

Mini

Type 10|12

- Lighting Fixtures
- Museums
- Interior Construction
- Shop Fittings



REUTLINGER[®]
systematic suspension

REUTLINGER – The only TÜV-certified holders



The TÜV-certificate – a safety guarantee from REUTLINGER.

TÜV-certification

All REUTLINGER holders shown in this catalogue have been certified

Holders type 10, type 12

Certificate-Nr.

Z1A 014229 0055 Rev. 00



REUTLINGER – the only TÜV-certified holders

The German TÜV is internationally renowned as a rigorous testing institution and is highly trusted by producers and consumers – especially for technical products.

The highest and most comprehensive level of TÜV-testing is GS-certification, denoting safe equipment and recognizable by the well-known blue TÜV/GS-sticker.

REUTLINGER is the world's only manufacturer of cable suspension systems that has succeeded in complying with the demands of GS-certification with every product line: our promise of safety confirmed by the "TÜV Süd".



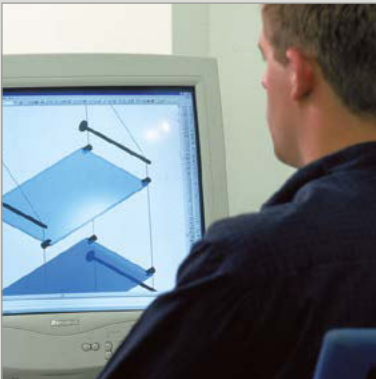

Product design with 3D-CAD-systems

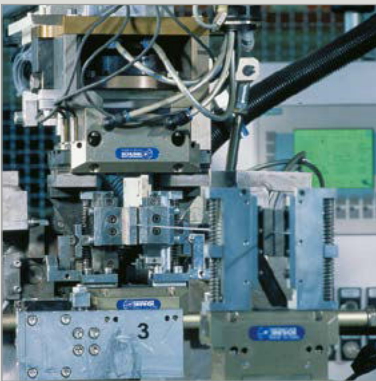

Fully automatic cable-production with testing

Loadable and flexible

Whether you're suspending light or small loads: REUTLINGER holders are infinitely adjustable up and down the cable without tools.

Unscrew safety-cap, suppress plunger, slide the holder, release the plunger and screw down the safety-cap – that's it.

REUTLINGER · Specialists for cable attachments and suspension **04**

Technical Information **05**

Type 10 **06**

Central cable exit 06
 Lateral cable exit07

Type 12 **08**

Central cable exit 08
 Lateral cable exit 09
 Special versions 10

Cables - Accessories **12**

Ceiling attachments12
 Cable ends 14
 Cables 15
 Cable clips..... 15

Contact **16**

REUTLINGER - Specialists for cable attachments and suspension



From a traditional workshop into a global high-tech company

„Technology should help us reach our goals. Therefore REUTLINGER constantly strives for logic and simplicity in all our products. Every detail must be functional and each function must make sense.“

Wolf Reutlinger, who has lead the company since 1987, continued this tradition of craftsmanship while initiating innovative processes which opened up new applications and markets.

WILHELM REUTLINGER
MECHAN. SEILERWAREN-
HANF- u. DRAHTSEIL- FABRIK
FRANKFURT A. M.

More than meets the eye

The use of REUTLINGER fastening attachments always results in permanent connections. This is the effect guaranteed by the self-locking mechanisms inside our holders. The elements devised specifically for this purpose are based on the following principle: the heavier the load – the greater the clamping force. For safe working loads (SWL) up to 330 kg.

By continually expanding the range of our products we were able to dominate the world market for suspended lighting fixtures within a few years. Today we are proud to count virtually all producers of high-quality lighting fixtures – as well as the automobile industry, sign- and shelf-manufacturers, galleries and museums – among our regular customers.

Customer demands – a constant incentive to innovate

Highly qualified employees, the use of modern CAD systems and fully automated production facilities allow us to consistently turn out innovative products of unvarying high quality. We individually develop and manufacture our products in close cooperation with our customers. We put all our know-how at the disposal of our customers – from initial planning to detailed construction and manufacture right up to final installation.

»Improve what is good, change what is ineffective«

Keeping an eye on quality and costs reflects this thinking – in all of our products. We pay special attention to the constant optimising of the following factors:

- increase loadability of the complete system
- reduce size to improve visual adaptability
- increase design variations
- reduce customers' installation time

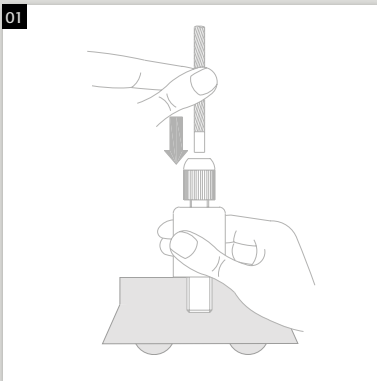

Adjusting without tools

First, the knurled cap is unscrewed a few thread-turns so the cable can be inserted (see illustration 1).

Once the holder is put in place the cap is screwed down until firm resistance is felt. This pulls the cable into the cone (see illustration 2).

Vertical readjustment of the holder follows the same procedure (see illustration 3).

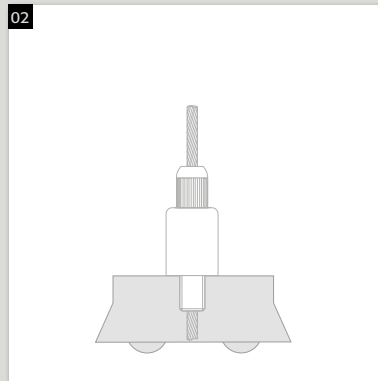

Inadvertent un-clamping through skewed loading or inattentiveness can no longer result in fallen loads.

We recommend occasional readjustment of the safety-cap.

Safety-caps

Safety-caps prevent inadvertent release of the clamping mechanism inside the holders. That's why the plunger is threaded. Safety-caps are available in various versions.

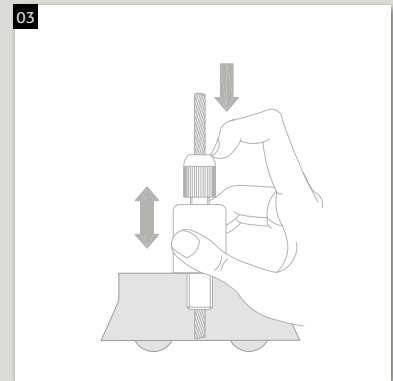

- Cylindrical safety-caps available with cross knurling or vertical knurling (see p. 9)
- Domed safety-caps are available with cross- oder vertical knurling, or without

Cables			Recommended cables & Safe Working Loads		
ø mm	Material	Construction	Serial number	Type 10	Type 12
0,45	Stainless steel	DIN EN 12385-4, 7x7, 1.570 N/mm ²	031.010.045	1,5 kg	
0,54	Stainless steel	DIN EN 12385-4, 7x7, 1.570 N/mm ²	031.010.054	2,5 kg	
0,63	Stainless steel	DIN EN 12385-4, 7x7, 1.570 N/mm ²	031.010.063	3,0 kg	4,0 kg
0,81	Stainless steel	DIN EN 12385-4, 7x7, 1.570 N/mm ²	031.010.081	7,0 kg	8,0 kg
	Steel zinc-plated silver	DIN EN 12385-4, 7x7, 2.300 N/mm ²	015.580.080	8,0 kg	9,0 kg
1,00	Stainless steel	DIN EN 12385-4, 7x7, 1.570 N/mm ²	031.010.101	10,0 kg	10,0 kg
	Steel zinc-plated silver	DIN EN 12385-4, 7x7, 2.300 N/mm ²	015.580.111	11,0 kg	13,0 kg
1,20	Stainless steel	DIN EN 12385-4, 7x7, 1.570 N/mm ²	031.010.121		15,0 kg
	Steel zinc-plated silver	DIN EN 12385-4, 7x7, 2.300 N/mm ²	015.580.121		17,0 kg

Chart 1: Recommended cables and Safe Working Loads

Holder type 10

Cable diameter 0.45 mm and 1.0 mm (all illustrations to scale)

10

Central cable exit

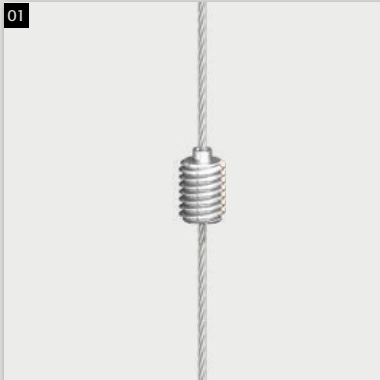

01
Holder type 10
M6x8

Diameter	6 mm
Length	8 mm
Coupling thread	M6
Thread length	8 mm
Art. no.	193.008.000

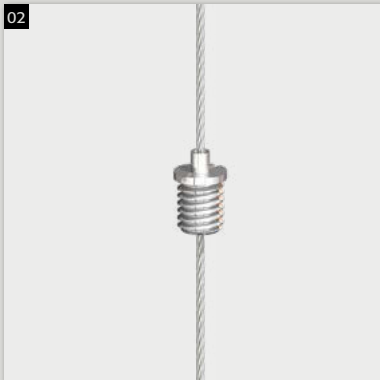

02
Holder type 10
M6x7 A7

Diameter	7 mm
Length	8 mm
Coupling thread	M6
Thread length	7 mm
Art. no.	193.008.005



03
Holder type 10
Hook

Diameter	9 mm
Length	20 mm
Art. no.	193.008.001



04
Holder type 10
fork M4x8 with safety bolt

Diameter	8 mm
Length	23 mm
Fork width	4 mm
Art. no.	193.008.002



05
Holder type 10
ball ø 9

Diameter	9 mm
Art. No.	193.008.003





Holder in use
(luminaire by TAL)

**Lateral
cable exit**



01
Holder type 10ZW
M4x4

Diameter	7 mm
Length	19 mm
Coupling thread	M4
Usable thread depth	4 mm
Art. No.	193.008.007

Holder type 10ZW
M3x4

Diameter	7 mm
Length	19 mm
Coupling thread	M3
Usable thread depth	4 mm
Art. No.	193.008.011



02
Holder type 10ZW
M4x4 slit 1.2 mm
with set-screw M4x4

Diameter	7 mm
Length	19 mm
Art. No.	193.008.006



Holder type 12

Cable diameter 1.0 and 1.2 mm (all illustrations to scale)

12

Central cable exit



01
Holder type 12
M8x10

Diameter	8 mm
Length	10 mm
Coupling thread	M8
Thread length	10 mm
Art. No.	193.000.098

**Holder type 12V M8x10
with knurled safety-nut M3**

Diameter	8 mm
Length	10 mm
Coupling thread	M8
Thread length	8 mm
Art. No.	193.000.766

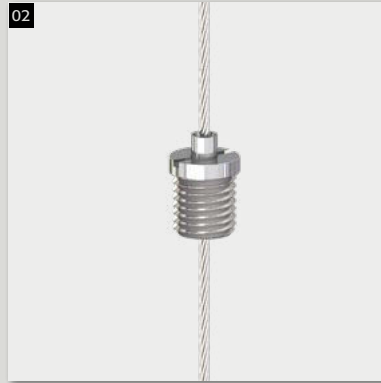

02
Holder type 12
M8x1 A9

Diameter	9 mm
Length	10 mm
Coupling thread	M8x1
Thread length	8 mm
Art. No.	193.000.139

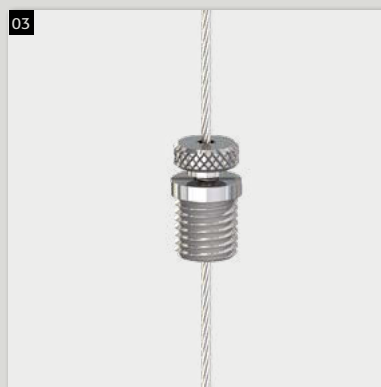

03
Holder type 12 M8x1 A9
with knurled safety-nut M3

Diameter	9 mm
Length	10 mm
Coupling thread	M8x1
Thread length	8 mm
Art. No.	193.000.137



04
Holder type 12
M4x7 o.R.

Diameter	8 mm
Length	21 mm
Coupling thread	M4
Thread length	6 mm
Art. No.	193.000.134

**Holder type 12
M4x7 m. LR**

Diameter	8 mm
Length	21 mm
Coupling thread	M4
Thread length	6 mm
Art. No.	193.000.133



**Lateral
cable exit**

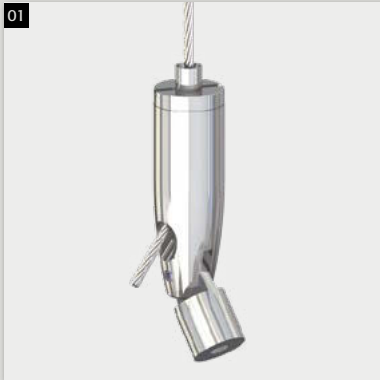

01
**Holder type 12 ZW
hinged M3i**

Diameter	9 mm
Length	32 mm
Coupling thread	M3i, M4i, M5i
Usable thread depth	4 mm
M3i Art. No.	193.002.075
M4i Art. No.	193.000.798
M5i Art. No.	193.000.887

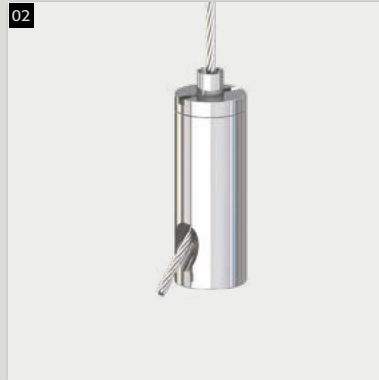

02
**Holder type 12 ZW
M3ix4**

Diameter/Length	9/24 mm
Coupling thread	M3i, M4i, M5i
Usable thread depth	4 mm
M3i Art. No.	193.000.281
M4i Art. No.	193.000.142
M5i Art. No.	193.001.722

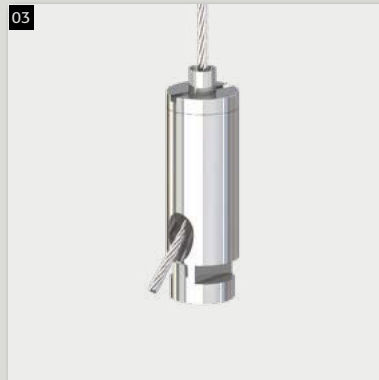

03
**Holder type 12 ZW-NK
with lateral cable exit**

Diameter/Length	8/26 mm
Flange width/depth from	3,5/8 mm
Flange height	2.5 mm
Art. No.	193.000.143

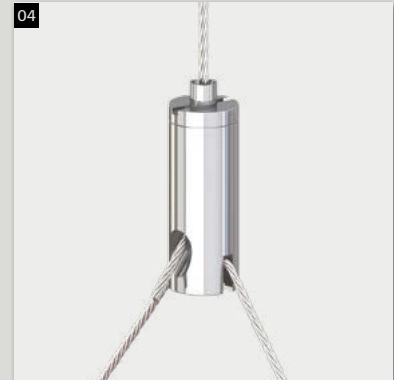

04
**Y-Holder type 12 ZW
M4ix4 Slit 1.6 mm
with set-screw Mx6**

Diameter	9 mm
Length	24 mm
Slit	1.6 mm
Art. No.	193.000.136

**Y-Holder type 12 ZW
M4ix4 Slit 1.6 mm
with set-screw M4**

Art. No.	193.000.777
----------	-------------

**Y-Holder type 12 ZW
M4ix4 lateral bore ø 1.6 mm
with set-screw M4**

Art. No.	193.000.763
----------	-------------

Holder type 12

Cable diameter 1.0 and 1.2 mm (all illustrations to scale)

12

Lateral cable exit



01
Y-Holder type 12 ZW with countersunk groove and set-screw M5x4

Diameter	9 mm
Length	25 mm
Groove-ø	3 mm
Art. No.	193.006.331

German utility patent
20.2007 008 350.5



02
Y-Holder type 12 ZW M8x1 with Y-docking part Type 12 M4x4 slit 1,6 mm and set-screw M4x15x5

Diameter	9 mm
Length	29 mm
Art. No.	193.000.894

Special versions



03
Insulation holder type 12 on low-voltage power feed nickel plated

for cable diameter	1.0 - 1.2 mm
with and without insulating	
Length	10 mm
Diameter	9 mm
Art. No.	193.002.040

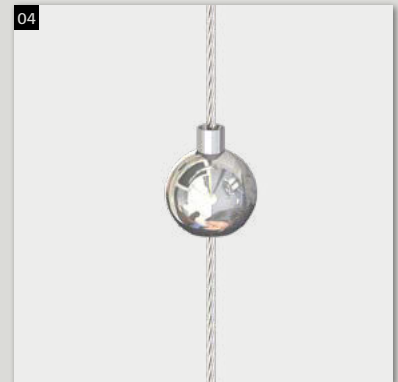

04
Holder type 12 ball ø 12

Diameter	12 mm
Art. No.	193.000.017



01
Holder type 12
N7x10

To attach securing- or clamping-plates

Diameter	8 mm
Diameter	10 mm
Groove-ø	7 mm
Groove height	1 mm
Length	10 mm
Art. No.	193.000.135



02
Holder type 12
M8x1 A9 with fork 5x10
and safety-bolt

Diameter	10 mm
Length	28 mm
Fork width	5 mm
Fork length	16 mm
bolt-ø	5 mm
Art. No.	193.000.141



03
Holder Type 12 ZW NK
M4 with flat hexagon nut M8x1

Diameter	8 mm
Length	29,7 mm
Wrench size	12x3 mm
Art. No.	193.006.239

Y-coupling parts



04
Combination Y-coupling part
M5x5 with Slit and set-screw
M5x6

for cable-ø 1,0 -1,5 mm

Diameter	6 mm
Length	17 mm
Thread length	5 mm
Art. No.	193.000.028



05
Combination Y-coupling part
M5x5 with lateral bore and
set-screw M5x6

for cable-ø 1,0 -1,5 mm

Diameter	6 mm
Length	17 mm
Thread length	5 mm
Art. No.	193.000.898

Accessories | Ceiling attachments

Single piece ceiling attachments



01

Ceiling attachment M6i o.R. SW7

Diameter	8 mm
Length	20 mm
Coupling thread	M6i
Wrench opening	7 mm
Art. No.	029.004.078



02

Ceiling attachment M6i m.R.

Diameter	10 mm
Length	20 mm
Coupling thread	M6i
Art. No.	029.006.200

Two-piece ceiling attachments



03

Ceiling attachment M8x1

Flange diameter	11 mm
Diameter	9 mm
Length	14 mm
Coupling thread	M8x1
with M6i Art. No.	193.001.380



04

Ceiling attachment M10x1

Flange diameter	16 mm
Diameter	12 mm
Length	115 mm
Coupling thread	M10x1
with M6i Art. No.	193.000.116



05

Screw cap M8x1 'Quick' with Slit

Length	10 mm
Coupling thread	M8x1, M10x1
Thread length	8 mm
M8x1 Art. No.	029.005.732
M10x1 Art. No.	029.005.705

German utility patent
20.2004 005 788.3

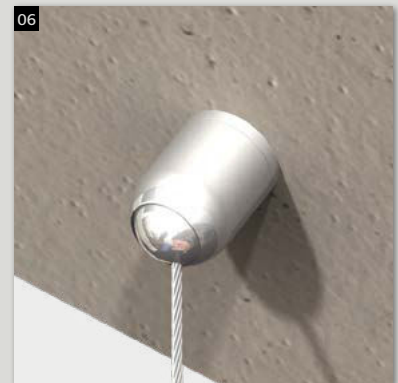

01

Ball joint ceiling attachment small, 360°

Diameter	16 mm
Length	12 mm
Coupling thread	M6i
Art. Nr.	193.003.177

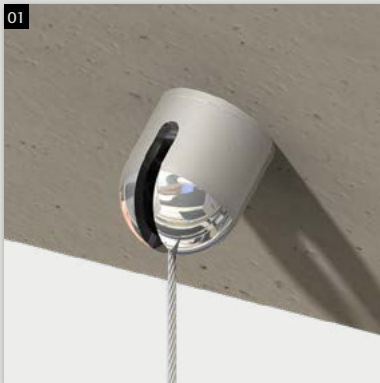

01
Ball joint ceiling attachment
big

Diameter	24 mm
Length	28 mm
Slit width	4,5 mm
Art. No.	193.000.170



02
Ball joint ceiling attachment
small

Diameter	16 mm
Length	22 mm
Slit width	2,1 mm
Art. No.	193.000.177

Ceiling
holder

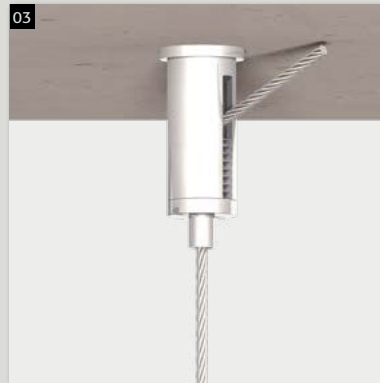

03
Ceiling attachment M8x1
with Slit and Holder Type 12
M8x1 A9

Diameter	11 mm
Length	22 mm
Coupling thread	M8x1
Thread length	8 mm
Art. No.	193.000.819

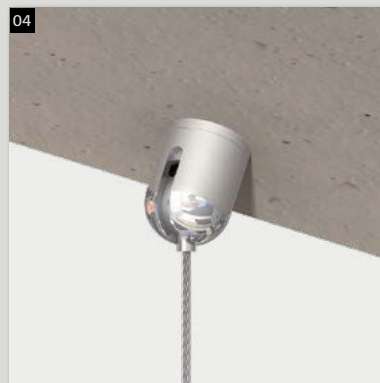

04
Ball joint ceiling attachment
Type10

Diameter	11 mm
Length	14.5 mm
Coupling thread	M6i
Art. No.	193.008.004



05
Ceiling attachment M10x1
with Slit and Holder Type 15
M10x6 A

Diameter	16 mm
Length	24 mm
Anschlussgewinde	M10x1
Thread length	12 mm
Art. No.	193.000.427

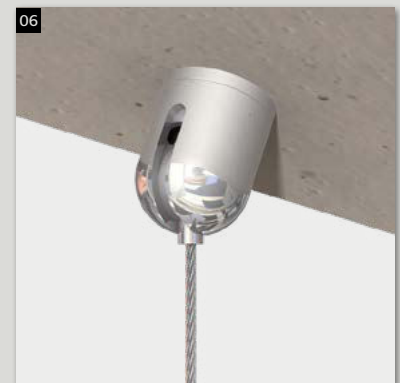

06
Ball joint ceiling attachment
Type12

Diameter	16 mm
Length	22 mm
Coupling thread	M6i
Art. No.	193.000.207

Further solutions
by request!

Accessories | Cable ends

On demand cables with various cable-ends custom-made to fit individual suspensions (length, materials, diameter.)



01
Loop

Dimensions according to drawing



02
Loop & thimble

Dimensions according to drawing

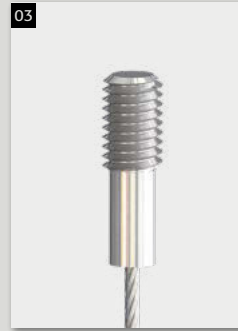

03
Threaded bolt

Dimensions according to drawing, M4, M5

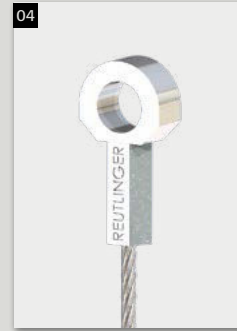

04
Eyelet

for bolts- \varnothing 5.0 mm

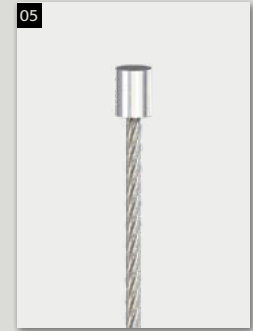

05
Cylinder sleeve

Dimensions according to drawing



06
T-sleeve 02

Head- \varnothing 6.0 mm
Length 8.5 mm

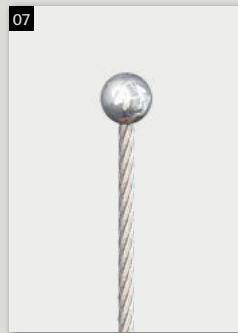

07
Ball-sleeve

\varnothing 3.0 to 6.0 mm



08
Wire eyelet

for bolts- \varnothing 6.0 mm
Max. WLL 10 kg



09
Wire hook

hook opening 4.0 mm

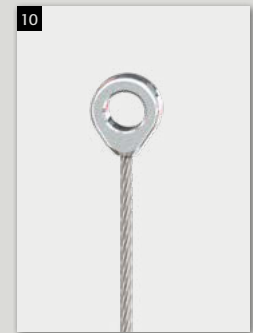

10
Z-eyelet \varnothing 5mm

\varnothing 1.2 mm
Length 10.0 mm

Cables				Terminals (cable ends)												
\varnothing mm	Material	Surface	Construction	Illustration												
				1	2	3	4	5	6	7	8	9	10			
0,45	Stainless Steel	Stainless Steel	DIN EN 12385-4, 7x7, 1.570 N/mm ²	○				○								
0,54	Stainless Steel	Stainless Steel	DIN EN 12385-4, 7x7, 1.570 N/mm ²	○				○								
0,63	Stainless Steel	Stainless Steel	DIN EN 12385-4, 7x7, 1.570 N/mm ²	○				○								
0,81	Stainless Steel	Stainless Steel	DIN EN 12385-4, 7x7, 1.570 N/mm ²	●	●	●	●	●	●	●	○	●	●			
	Steel	Silver zinc-plated	DIN EN 12385-4, 7x7, 2.300 N/mm ²	●	●	●	●	●	●	●	○	●	●			
1,00	Stainless Steel	Stainless Steel	DIN EN 12385-4, 7x7, 1.570 N/mm ²	●	●	●	●	●	●	●	●	●	●	●		
	Steel	Silver zinc-plated	DIN EN 12385-4, 7x7, 2.300 N/mm ²	●	●	●	●	●	●	●	●	●	●	●		
1,20	Stainless Steel	Stainless Steel	DIN EN 12385-4, 7x7, 1.570 N/mm ²	●	●	●	●	●	●	●	●	●	●	●		
	Steel	Silver zinc-plated	DIN EN 12385-4, 7x7, 2.300 N/mm ²	●	●	●	●	●	●	●	●	●	●	●		

Chart 2: Cables and cable-ends (● = available, ○ = on demand)

Cables for Holders

1. Materials and coatings

Cables are available in two degrees of durability

- 1.1. galvanized steel for normal indoor use;
- 1.2. stainless steel for exterior use and decorative requirements

2. Specific cable strength

Along with the standard strength cables with 1,570 N/mm² we also offer high-tensile- strength cables with up to 2,400 N/mm². With these you get a higher system strength with the same cable diameter.

3. Cable construction

The new cables for Holders are all very flexible, no matter what construction. Therefore we normally offer only 6x7+WSC (aka 7x7). Should cables have to run on wheels, a special solution must be found.

4. Cable diameter

REUTLINGER offers cables from 0.8 mm to 1.2 mm suitable for Holders.

5. Use of other cables

REUTLINGER cables are free of tension, stress-free, not twisted and cut-proofed. When using other cables take care that cutting does not untwist the cable, because it's possible that they will not fit into the holder after they have been tinned.

6. Individual solutions

Let us help you choose the best solution among our variety of cable ends.

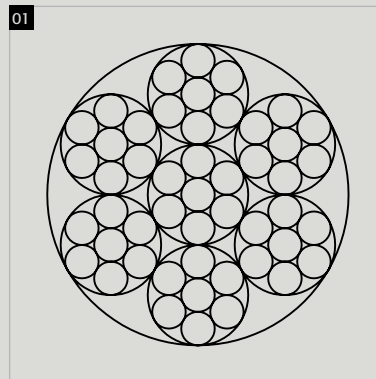

01 DIN EN 12385-4 6x7+1WSC

Attaching power-feeds to cables

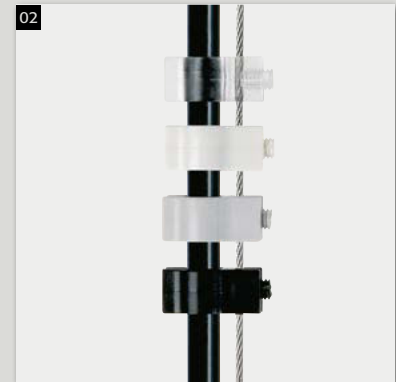

02 Cable clip ›Flex Plus small‹

Power-feed-ø	5.0 - 8.0 mm
Cable-ø	1.0 - 2.0 mm
Colour	Art. No.
black	029.006.598
white	029.006.595
grey	029.006.596
transparent	029.006.597

Cable clip ›Flex Plus large‹

Power-feed-ø	7.0 - 10.5 mm
cable-ø	1.0 - 2.0 mm
Colour	Art. No.
black	029.006.592
white	029.006.590
grey	029.006.593
transparent	029.006.594

Cable clip ›Flex Standard‹

Power-feed-ø	6.0 - 8.0 mm
Cable-ø	1.0 - 1.6 mm
Colour	Art. No.
black	029.005.124
white	029.005.123
transparent	029.005.249



**Please request
the following catalogs:**

Mini Holders & Accessories
Type 10, 12

Standard
Holders & Accessories
Type 15, 18, 20

Heavy Duty
Holders & accessories
Type 25, 30, 50, 66, 80

Shop | Display
Presentation – and Shelving –
Systems for retail applications

Gallery
Suspension systems for
galleries and exhibits

Event Technology
Holders and Accessories
Type 50 SV III, Type 66 SV III,
Type 80 SV III

Current-Carrying Suspensions
Suspension of Luminaires,
Lightboxes, Displays and Other
Objects

Have we gotten you interested?
Do you have questions concerning
technical details? Please give us a
call!

Reutlinger GmbH

Züricher Str. 3
60437 Frankfurt / Main
Germany

Phone +49 (0) 69 965228-0
Telefax +49 (0) 69 965228-30

E-Mail info@reutlinger.de
Internet www.reutlinger.de

Managing Director
Dipl.-Ing. Wolf Reutlinger

HRB Frankfurt 33321
USt-ID DE 114 209 718